

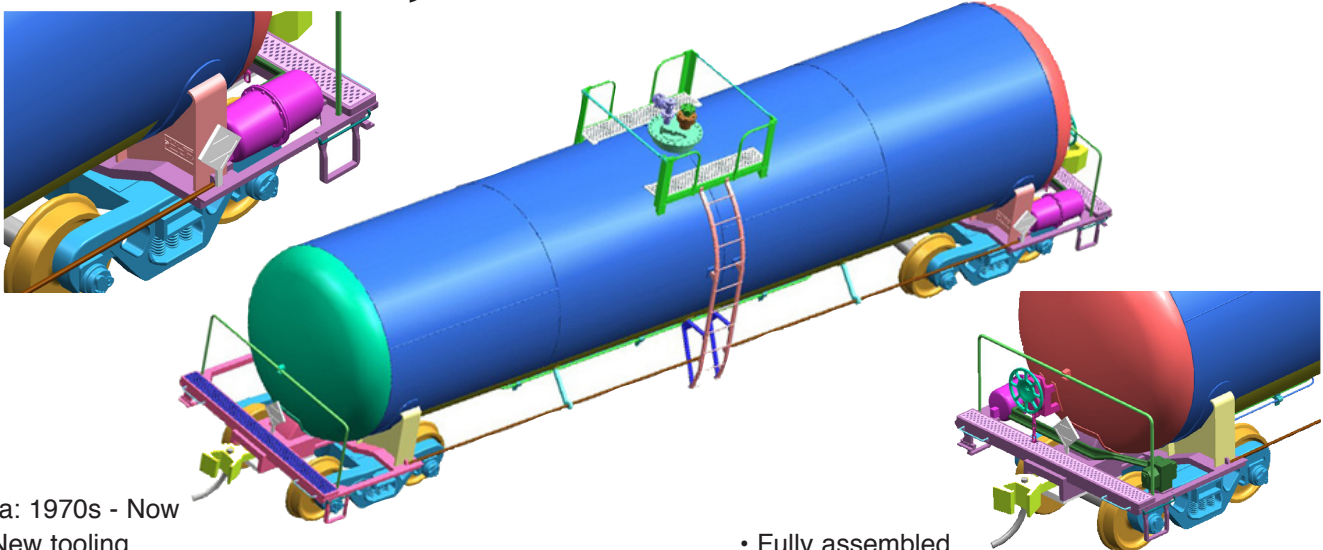

Announced: 2-24-09  
**Orders Due: 3-20-08**  
 ETA: September 2009

# 50' RTC 20,900 Gal Acid Tank Car



Era: 1970s - Now

- New tooling
- Weighted for optimal performance
- Metal wire form grab irons
- Equipped with McHenry® scale AAR upper/lower shelf knuckle couplers per prototype practice
- Fully assembled
- Photo-etched platforms
- RP25 profile machined metal wheel sets

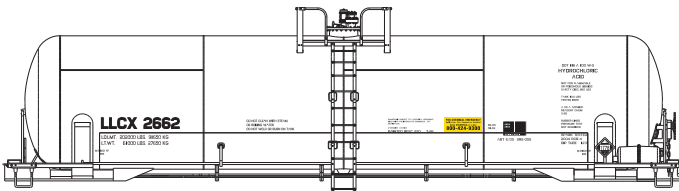

\_\_\_ 73914 LLCX #1 \$27.98  
 \_\_\_ 73915 LLCX #2 \$27.98

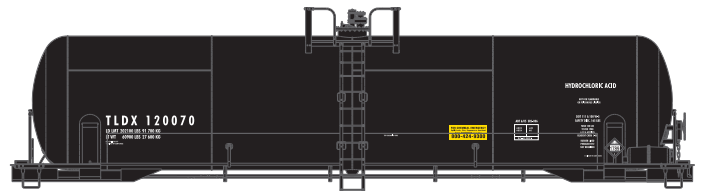

\_\_\_ 73920 TLDX #1 \$27.98  
 \_\_\_ 73921 TLDX #2 \$27.98

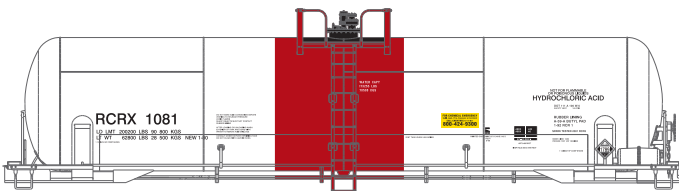

\_\_\_ 73916 RCRX #1 \$27.98  
 \_\_\_ 73917 RCRX #2 \$27.98

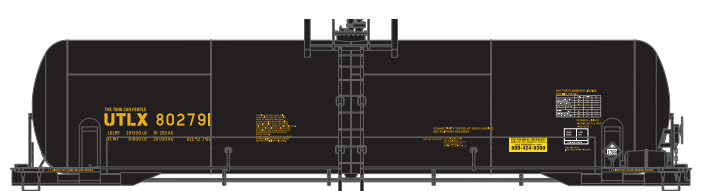

\_\_\_ 73922 UTLX (black) #1 \$27.98  
 \_\_\_ 73923 UTLX (black) #2 \$27.98

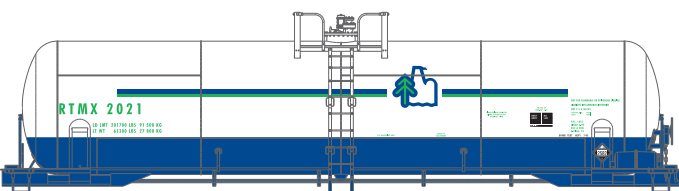

\_\_\_ 73918 RTMX-Eaglebrook #1 \$27.98  
 \_\_\_ 73919 RTMX-Eaglebrook #2 \$27.98

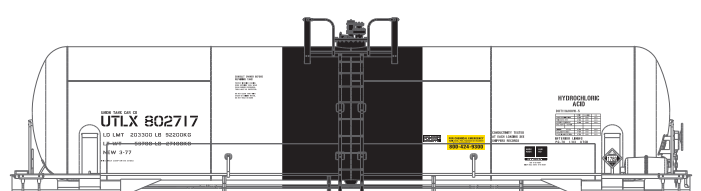

\_\_\_ 73924 UTLX (white) #1 \$27.98  
 \_\_\_ 73925 UTLX (white) #2 \$27.98  
 \_\_\_ 73913 Undecorated \$27.98

Athearn Trains • 1550 Glenn Curtiss Street • Carson, CA • 90746  
 310-763-7140 • fax 310-763-7449 • www.athearn.com