



# HO ACF 2970 Covered Hopper

Announced: 07.25.14  
Orders Due: 08.22.14

ETA: March 2015

## ACF Leasing

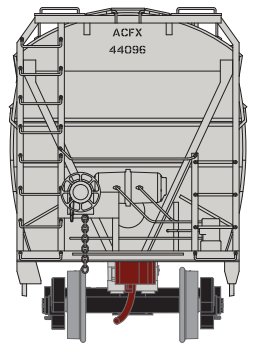
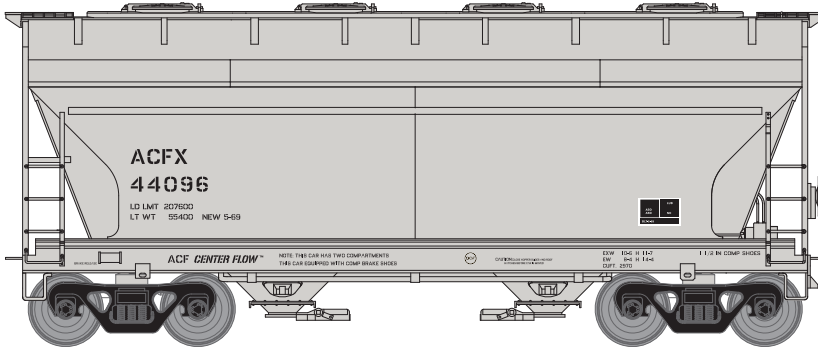
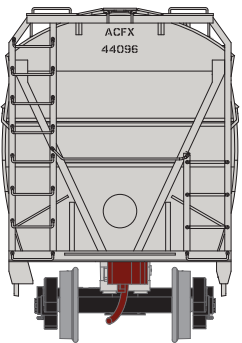
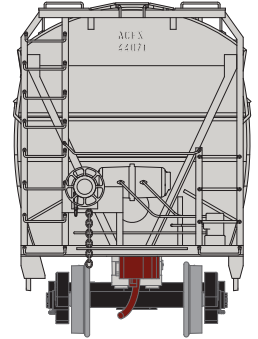
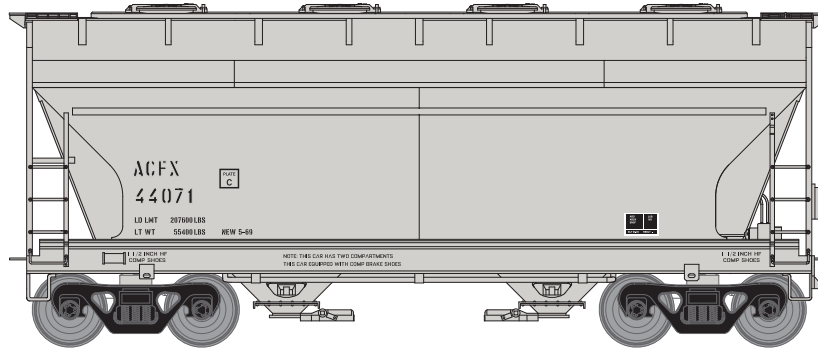
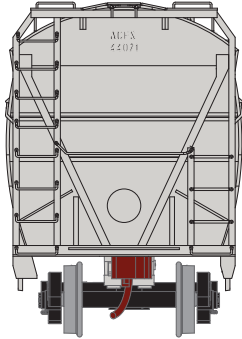

Era: 1969+

ATH98168 #44071  
ATH98169 #44076  
ATH98170 #44096

## Bay State Milling

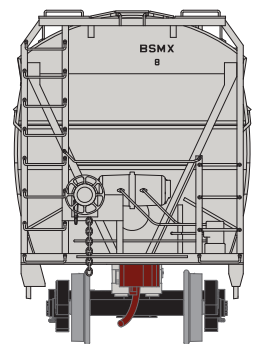
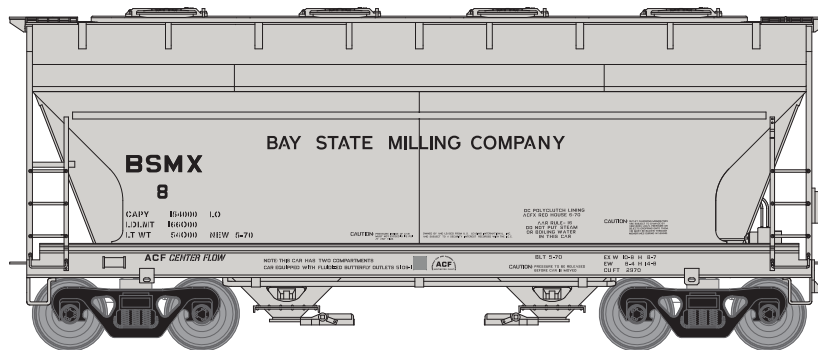
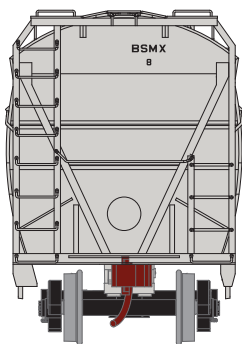

Era: 1970+

ATH98171 #8  
ATH98172 #13  
ATH98173 #16

**\$39.98**





# HO ACF 2970 Covered Hopper

Announced: 07.25.14  
Orders Due: 08.22.14

ETA: March 2015

## Burlington Northern Santa Fe



Era: 1996+



ATH98174 #406020  
ATH98175 #406045  
ATH98176 #406077



## Great Northern

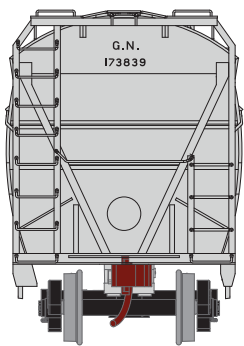

Era: 1968+



ATH98177 #173839  
ATH98178 #173854  
ATH98179 #173982

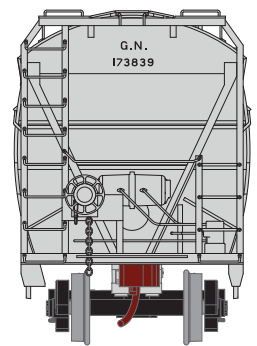

## Missouri Pacific / Texas & Pacific\*

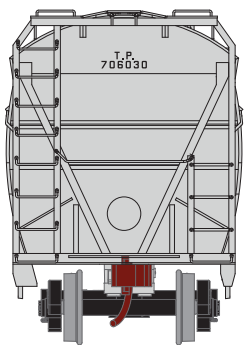

Era: 1967+

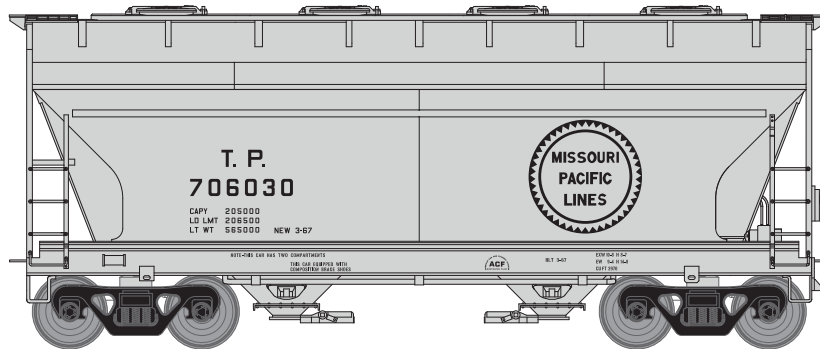

ATH98180 #706030  
ATH98181 #706074  
ATH98182 #706092

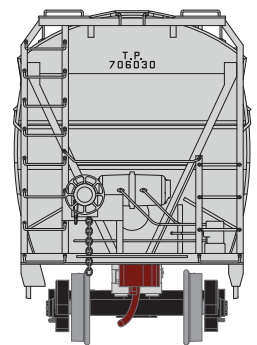

\* Union Pacific Licensed Product

\$39.98





# HO ACF 2970 Covered Hopper

Announced: 07.25.14  
Orders Due: 08.22.14

ETA: March 2015

## Union Pacific\*

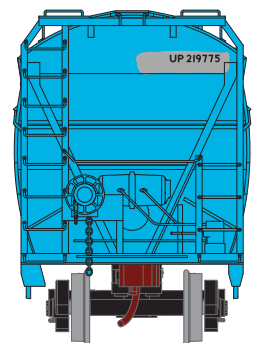
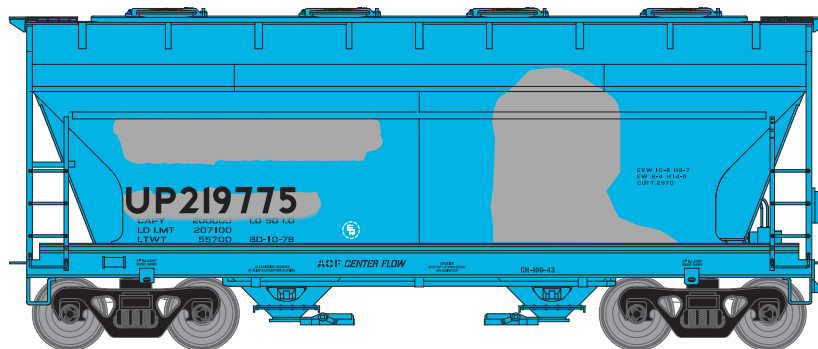
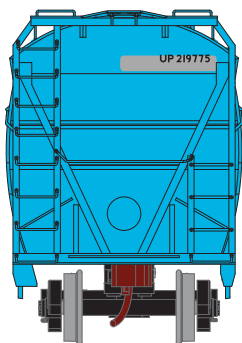
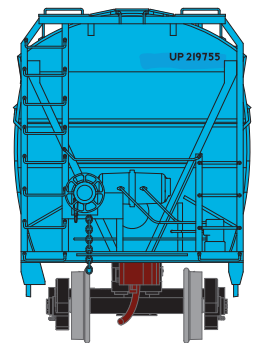
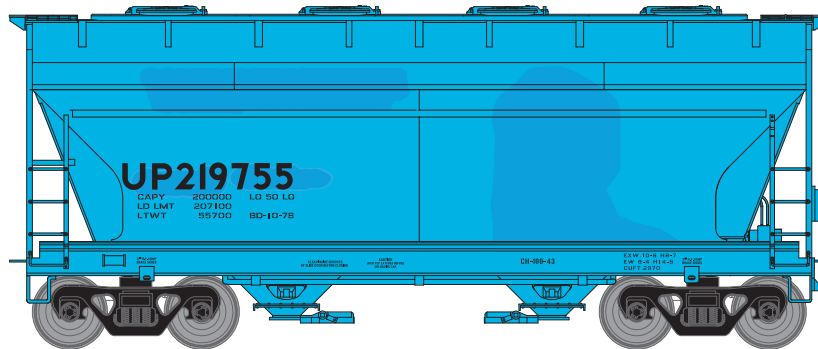
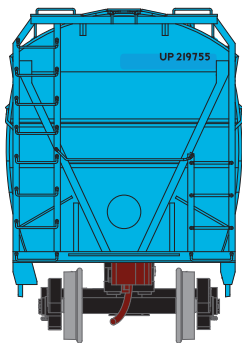
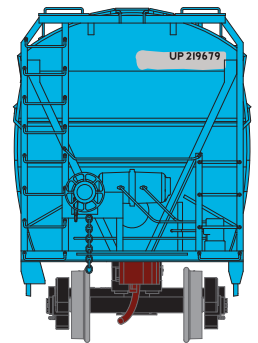
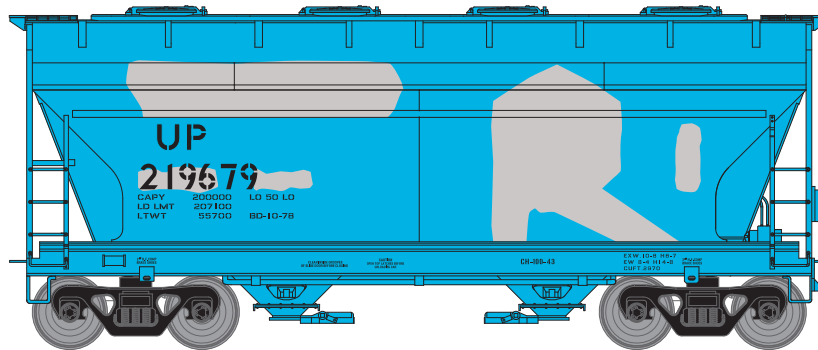
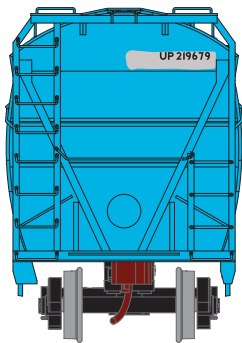

Era: 1980+  
ex-Rock Island car

ATH98183  
ATH98184  
ATH98185

#219679  
#219755  
#219775

### MODEL FEATURES

- Round or trough hatches
- Photo-etched metal roof walk
- Separately applied wire grab irons and stirrup steps
- Detailed outlets
- Multiple road numbers
- Accurately painted and printed
- Highly detailed, injection molded body
- Separate brake wheel, cylinder, valve and air reservoir with wire brake plumbing
- Machined metal wheels with RP25 contours operate on Code 75, 83, 100 rail
- Body mounted McHenry® operating scale knuckle couplers
- Weighted for trouble free operation
- Minimum radius: 18"

\* Union Pacific Licensed Product

# \$39.98

